



KIT CONTAINS

UNIDRAIN GLASSLINE UNIT WITH
INTEGRATED GLASS CHANNEL
MULTI DIRECTIONAL OUTLET
HIGHLINE FRAME
HIGHLINE CASSETTE
GLASS SCREEN

5002.0912 | 5003.0912 Glassline Module

For right-aligned shower screen

For left-aligned shower screen



ITEM NUMBER R

5002.0912

ITEM NUMBER L

5003.0912

Specifications

MATERIAL	SURFACE	FLOORING
1,5 mm stainless steel (AISI 304)	Pickled	Tiles
MEMBRANE	FLOOR CONSTRUCTION	INSTALLATION WIDTH (A)
Liquid or sheet membrane	Concrete/wood	901 mm
INSTALLATION DEPTH (B)	CENTRE (C)	SHOWER SCREEN SIZE (D)
1301 mm	451 mm	1200 mm

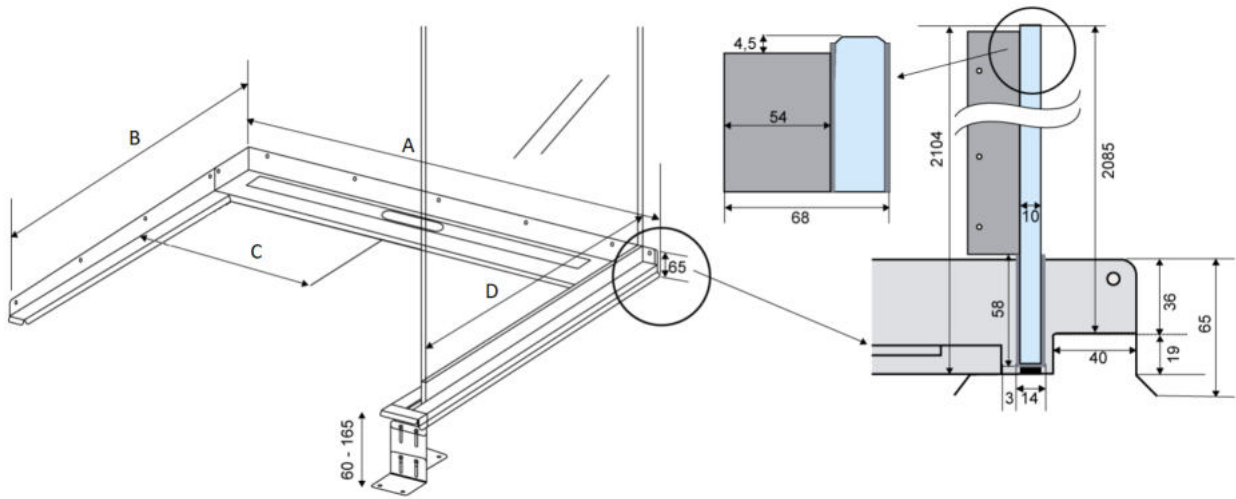

1416.0050 - Multi Directional Outlet

Line 1416.0050

Ø 50 mm horizontal drain

Can be rotated 180 degrees if a rear-facing outlet is required.

Note two drains. Cannot be used as an inlet.



Specifications

ITEM NUMBER	GTIN NUMBER	WEIGHT INCLUDING PACKAGING
1416.0050	5707692012520	505 g
WEIGHT EXCLUDING PACKAGING	MATERIAL	USAGE
312 g	Plastic (PP)	Line drain
BARRIER	GASKET	CAPACITY
With	EPDM	0,8 l/s
SIDE INLET	CENTER	FITS DRAIN UNIT
Without	32 mm	1001, 1002, 1003, 1004, 1100, 3002, 3004, 5002, 5003, 4004

FITTING HEIGHTS - LINE FAUCETS 1001, 1002, 1003, 1004

Ø	Outlet direction	300	600	700	800	900	1000	1200
Ø 50 mm	Horizontal	98 mm	102 mm	103 mm	104 mm	105 mm	106 mm	108 mm

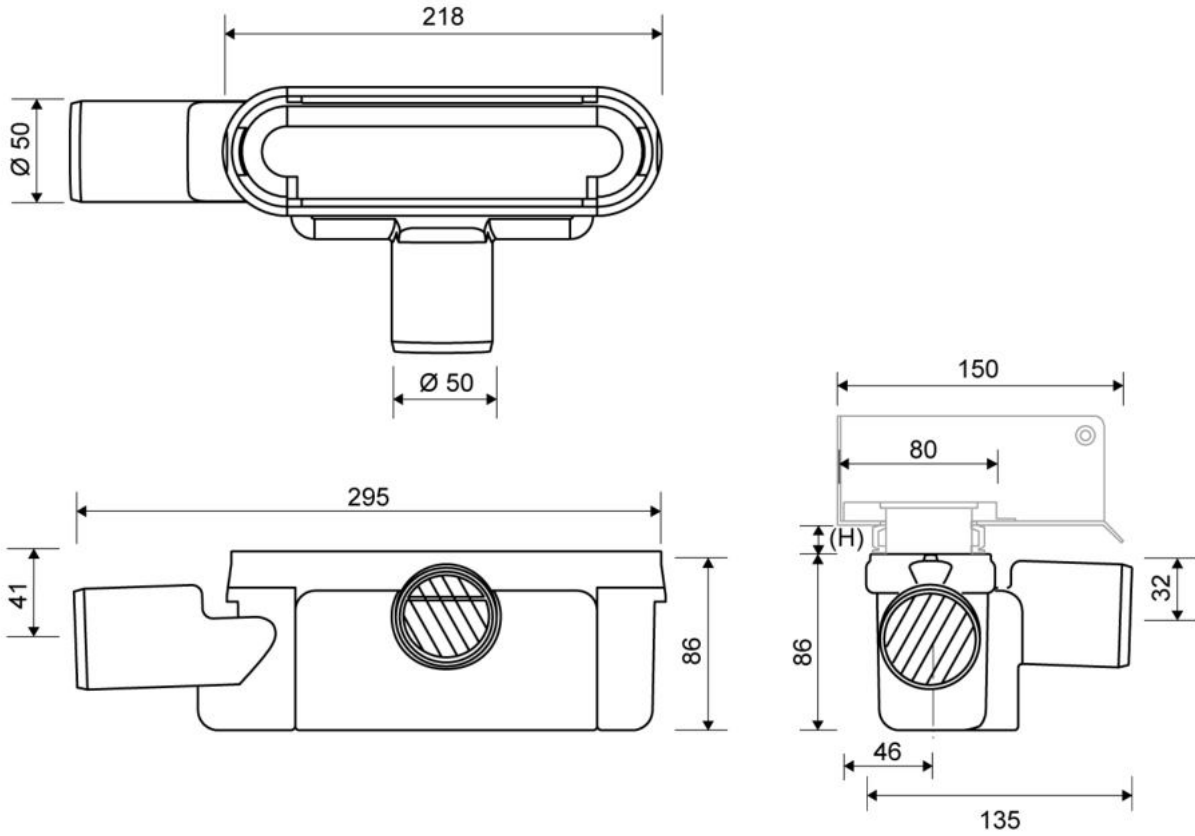

1910.0915 - 900mm Stainless Steel Frame

Line 1910

Highline Frame can be placed around Highline Custom, Cassette and Panel.
Also available in 10, 12 and 25mm heights (depending on the thickness of the floor tile)
Contact Wetroom Materials for other heights.

Must be installed before tiling.



Specifications

ITEM NUMBER	GTIN NUMBER	WEIGHT INCLUDING PACKAGING
1910.0915	5707692004396	2380 g
WEIGHT EXCLUDING PACKAGING	MATERIAL	USAGE
2270 g	Stainless steel (AISI 304)	Line drain
SURFACE	INSTALLATION LENGTH (L)	HEIGHT (H)
Brushed	895 mm	H 12 mm
LENGTH MODEL	FITS DRAIN UNIT	INSERT
900 mm	1001, 1002, 1003, 1004, 1100, 5002, 5003	Synthetic



1940.0915 - 900mm Cassette

HighLine | Cassette

The set consists of a Highline Cassette to place tile into, heightener set and screws.

Can be used with or without Highline Frame.

When using without Highline Frame, ensure rear wall build up allows for equal drainage gap on all sides.

Also available in 10, 12 and 25 mm heights (depending on the thickness of the floor tile).

Contact Wetroom Materials for other heights.



Specifications

ITEM NUMBER	GTIN NUMBER	WEIGHT INCLUDING PACKAGING
1940.0915	5707692005232	1760 g
WEIGHT EXCLUDING PACKAGING	MATERIAL	USAGE
1650 g	Stainless steel (AISI 304)	Line drain
SURFACE	HEIGHT (H)	LENGTH MODEL
Brushed	H 15 mm	900 mm
HEIGHTENER SET	LENGTH WITH/WITHOUT FRAME	
Plastic (PE)	833/895 mm	

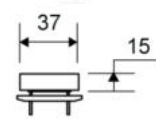
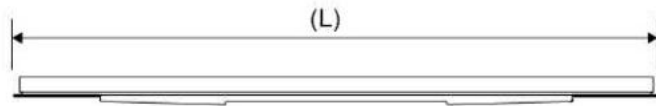
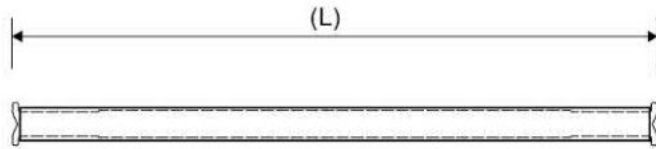

5100.1200

GlassLine | Right and left-aligned shower screen

Design: Transparent

10 mm safety glass

No visible screws or fittings in the finished result

The glass surface is treated with Cleantec nanotechnology, making it water-repellent, less susceptible to limescale and easier to clean.



Specifications

ITEM NUMBER	LENGTH MODEL	HEIGHT (H)
5100.1200	1200 mm	2104 mm
DESIGN	MATERIAL	
Transparent	Stainless steel (AISI 304) 10 mm safety float glass	

